

# MITSUBISHI

## ENGINE

### 4G9 SERIES (E-W)

## WORKSHOP MANUAL

### FOREWORD

This Workshop Manual contains procedures for removal, disassembly, inspection, adjustment, reassembly and installation, etc. for service mechanics.

All information, illustrations and product descriptions contained in this manual are current as at the time of publication. We, however, reserve the right to make changes at any time without prior notice or obligation.

Engine ..... **11A**

#### FILING INSTRUCTION

Please keep these manual pages in the binder No. BN940001.

File these pages according to the signs "Added", "Revised" and "Deleted" on the "List of effective pages" which are interpreted below.

**Added:**

File the pages with this sign additionally in your manual.

**Revised, Deleted:**

Replace the existing pages with the corresponding pages with this sign.

Missing sheets will be supplied upon request.

 MITSUBISHI MOTORS CORPORATION

Pub. No. PWEE9502-F



## EXPLANATION OF MANUAL CONTENTS

### Maintenance and Servicing Procedures

- (1) A diagram of the component parts is provided near the front of each section in order to give the reader a better understanding of the installed condition of component parts.
  - (2) The numbers provided within the diagram indicate the sequence for maintenance and servicing procedures.  
**N** : Indicates a non-reusable part.  
The tightening torque is provided where applicable.
- **Removal steps:**  
The part designation number corresponds to the number in the illustration to indicate removal steps.
  - **Disassembly steps:**  
The part designation number corresponds to the number in the illustration to indicate disassembly steps.
  - **Installation steps:**  
Specified in case installation is impossible in reverse order of removal steps. Omitted if installation is possible in reverse order of removal steps.
  - **Reassembly steps:**  
Specified in case reassembly is impossible in reverse order of disassembly steps. Omitted if reassembly is possible in reverse order of disassembly steps.





### Classification of Major Maintenance/Service Points

When there are major points relative to maintenance and servicing procedures (such as essential maintenance and service points, maintenance and service standard values, information regarding the use of special tools, etc.), these are arranged together as major maintenance and service points and explained in detail.

-  : Indicates that there are essential points for removal or disassembly.  
 : Indicates that there are essential points for installation or reassembly.

### Symbols for Lubrication, Sealants and Adhesives

Information concerning the locations for lubrication and for application of sealants and adhesives is provided, by using symbols, in the diagram of component parts, or on the page following the component parts page, and explained.

-  : Grease (multipurpose grease unless there is a brand or type specified)
-  : Sealant or adhesive
-  : Brake fluid, automatic transmission fluid or air conditioner compressor oil
-  : Engine oil or gear oil

# INTRODUCTION

Indicates the group title.

Indicates the section title.

Indicates the group number.

Indicates the section number.

Indicates the page number.

4G9 ENGINE (E-W) - Water Pump and Water Hose

11A-7-1

## 7. WATER PUMP AND WATER HOSE REMOVAL AND INSTALLATION <SOHC>

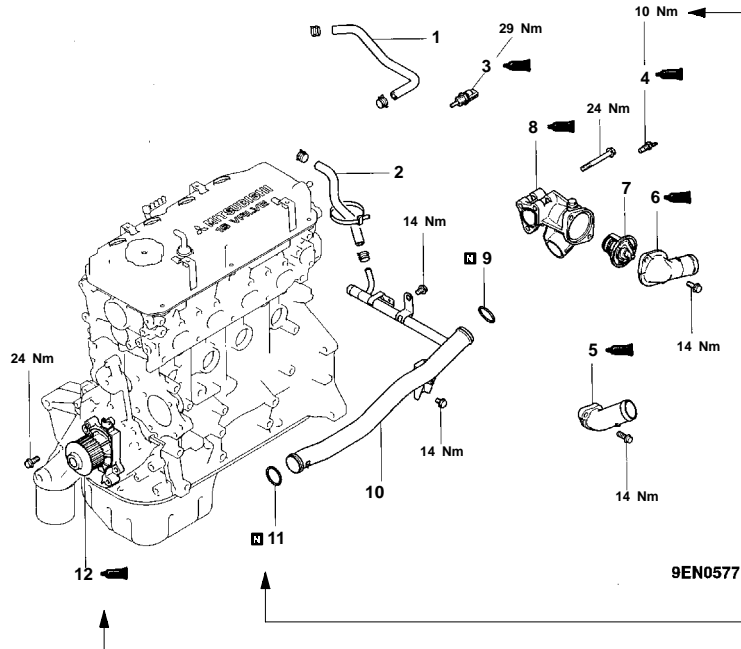

Denotes tightening torque.

Denotes non-reusable part.

This number corresponds to the number appearing in "Removal steps", "Disassembly steps", "Installation steps" or "Reassembly steps".

### Removal steps

1. Water hose A
2. Water hose B
- ▶G▶ 3. Engine coolant temperature sensor
- ▶F▶ 4. Engine coolant temperature gauge unit
- ▶E▶ 5. Water outlet fitting
6. Water inlet fitting

- ▶D▶ 7. Thermostat
- ▶C▶ 8. Thermostat case
- ▶B▶ 9. O-ring
- ▶B▶ 10. Water inlet pipe
- ▶B▶ 11. O-ring
- ▶A▶ 12. Water pump

Operating procedures, cautions, etc. on removal, installation, disassembly and reassembly are described.

### INSTALLATION SERVICE POINTS

#### ▶A▶ WATER PUMP INSTALLATION

- (1) Apply a 3 mm diameter of Form-In-Place Gasket (FIPG) to the location shown in the illustration.

**Specified sealant:**  
Mitsubishi Genuine Part No. MD970389 or equivalent.

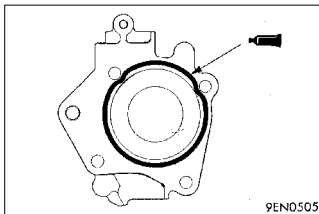

## LIST OF EFFECTIVE PAGES

Page	Revision Code	Date	Remarks	Page	Revision Code	Date	Remarks
11A-0-1	E	Dec. 1998		11A-6c-1 to 11A-6c-5	E	Dec. 1998	
11A-0-3 and 11A-0-4	C	July 1997		11A-7-1	B	Nov. 1996	
11A-1-1 to 11A-1-6	E	Dec. 1998		11A-7-2		May 1995	
11A-1-6a and 11A-1-6b	E	Dec. 1998		11A-7-3 to 11A-7-5	E	Dec. 1998	
11A-1-7	E	Dec. 1998		11A-8-1		May 1995	
11A-1-8		May 1995		11A-8-2 to 11A-8-13	E	Dec. 1998	
11A-2-1 to 11A-2-3	A	Nov. 1995		11A-8a-1 to 11A-8a-5	A	Nov. 1995	
11A-3-1	A	Nov. 1995		11A-8b-1 and 11A-8b-2	A	Nov. 1995	
11A-3-2	E	Dec. 1998		11A-9-1 and 11A-9-2		May 1995	
11A-3-2a and 11A-3-2b	E	Dec. 1998		11A-9-3	A	Nov. 1995	
11A-3-3 and 11A-3-4	A	Nov. 1995		11A-9-3a and 11A-9-3b	C	July 1997	
11A-3-5 to 11A-3-7	E	Dec. 1998		11A-9-4 to 11A-9-8	A	Nov. 1995	
11A-4-1 and 11A-4-2	E	Dec. 1998		11A-9-9	C	July 1997	
11A-4-2a to 11A-4-2d	E	Dec. 1998		11A-9-10	E	Dec. 1998	
11A-4-3	A	Nov. 1995		11A-9-11	C	July 1997	
11A-4-4		May 1995		11A-9-12	A	Nov. 1995	
11A-4-5 and 11A-4-6	A	Nov. 1995		11A-10-1		May 1995	
11A-4-7 to 11A-4-9		May 1995		11A-10-2	D	Jun. 1998	
11A-5-1	B	Nov. 1996		11A-10-3 to 11A-10-7	E	Dec. 1998	
<b>11A-5-2</b>	<b>F</b>	<b>July 1999 Revised</b>		11A-11-1		May 1995	
11A-5-3 to 11A-5-6	E	Dec. 1998		11A-11-2	A	Nov. 1995	
11A-5a-1 to 11A-5a-3	E	Dec. 1998		11A-11-3 to 11A-11-8		May 1995	
11A-6-1 to 11A-6-4	B	Nov. 1996		11A-12-1	C	July 1997	
11A-6a-1 and 11A-6a-2	D	Jun. 1998		11A-12-1a and 11A-12-1b	E	Dec. 1998	
11A-6a-3 and 11A-6a-4	E	Dec. 1998		11A-12-2 to 11A-12-6	A	Nov. 1995	
11A-6b-1 to 11A-6b-3	E	Dec. 1998		11A-12-7	E	Dec. 1998	

Missing sheets will be supplied upon request.