

mitsubishi

ENGINE 6G7 SERIES (E-W)

WORKSHOP MANUAL

FOREWORD

This Workshop Manual contains procedures for removal, disassembly, inspection, adjustment, reassembly and installation, etc. for service mechanics.

All information, illustrations and product descriptions contained in this manual are current as at the time of publication. We, however, reserve the right to make changes at any time without prior notice or obligation.

Engine **11A**

FILING INSTRUCTION

Please keep these manual pages in the binder No. BN890001.

File these pages according to the signs "Added", "Revised" and "Deleted" on the "List of effective pages" which are interpreted below.

Added:

File the pages with this sign additionally in your manual.

Revised, Deleted:

Replace the existing pages with the corresponding pages with this sign.

Missing sheets will be supplied upon request.



Pub. No. PWEE9615



EXPLANATION OF MANUAL CONTENTS

Maintenance and Servicing Procedures

- (1) A diagram of the component parts is provided near the front of each section in order to give the reader a better understanding of the installed condition of component parts.
 - (2) The numbers provided within the diagram indicate the sequence for maintenance and servicing procedures.
 - N**: Indicates a non-reusable part. The tightening torque is provided where applicable.
- **Removal steps:**
The part designation number corresponds to the number in the illustration to indicate removal steps.
 - **Disassembly steps:**
The part designation number corresponds to the number in the illustration to indicate disassembly steps.
 - **Installation steps:**
Specified in case installation is impossible in reverse order of removal steps. Omitted if installation is possible in reverse order of removal steps.
 - **Reassembly steps:**
Specified in case reassembly is impossible in reverse order of disassembly steps. Omitted if reassembly is possible in reverse order of disassembly steps.





Classification of Major Maintenance/Service Points

When there are major points relative to maintenance and servicing procedures (such as essential maintenance and service points, maintenance and service standard values, information regarding the use of special tools, etc.), these are arranged together as major maintenance and service points and explained in detail.

-  : Indicates that there are essential points for removal or disassembly.
-  : Indicates that there are essential points for installation or reassembly.

Symbols for Lubrication, Sealants and Adhesives

Information concerning the locations for lubrication and for application of sealants and adhesives is provided, by using symbols, in the diagram of component parts, or on the page following the component parts page, and explained.

-  : Grease (multipurpose grease unless there is a brand or type specified)
-  : Sealant or adhesive
-  : Brake fluid, automatic transmission fluid or air conditioner compressor oil
-  : Engine oil or gear oil

INTRODUCTION

Indicates the group title.

Indicates the section title.

Indicates the group number.

Indicates the section number.

Indicates the page number.

6G7 ENGINE (E-W) - Intake Manifold

11A-7-1

7. INTAKE MANIFOLD REMOVAL AND INSTALLATION

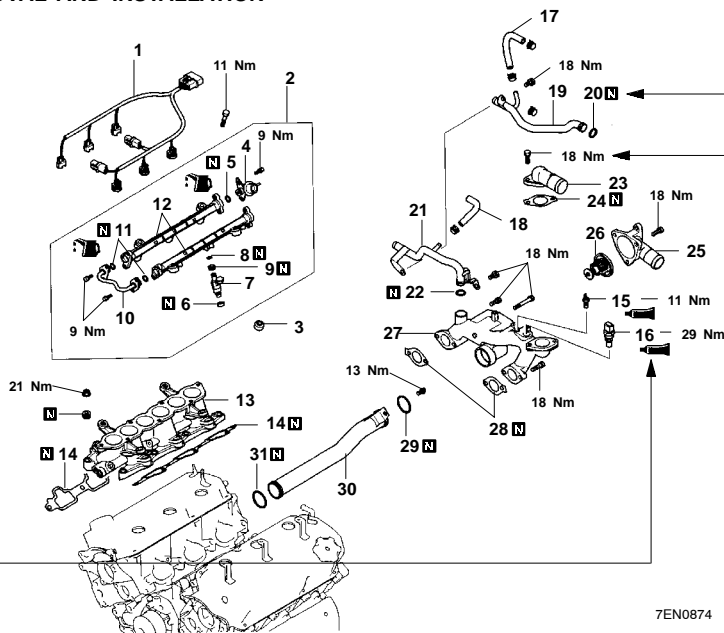

Removal Procedure

1. Engine harness
2. Injector and delivery pipe
3. Insulator
- ▶H◀ 4. Fuel pressure regulator
- ▶H◀ 5. O-ring
- ▶G◀ 6. Insulator
- ▶G◀ 7. Injector
8. O-ring
9. Grommet
10. Fuel pipe
11. O-ring
- ▶F◀ 12. Delivery pipe
- ▶F◀ 13. Intake manifold
- ▶F◀ 14. Intake manifold gasket
- ▶E◀ 15. Engine coolant temperature gauge unit

- ▶D◀ 16. Engine coolant temperature sensor
17. Water hose
18. Water hose
- ▶C◀ 19. Heater inlet pipe
- ▶A◀ 20. O-ring
- ▶C◀ 21. Heater inlet pipe
- ▶A◀ 22. O-ring
- ▶A◀ 23. Water outlet fitting
- ▶A◀ 24. Water outlet fitting gasket
- ▶B◀ 25. Water inlet fitting
- ▶B◀ 26. Thermostat
- ▶B◀ 27. Thermostat housing
- ▶A◀ 28. Thermostat housing gasket
- ▶A◀ 29. O-ring
- ▶A◀ 30. Water pipe
- ▶A◀ 31. O-ring

INSTALLATION SERVICE POINTS

▶A◀ O-RING/WATER PIPE

- (1) Wet the O-ring (with water) to facilitate assembly.

Caution

- Keep the O-ring of oil or grease.

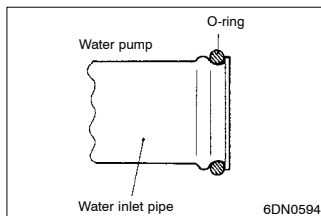

© Mitsubishi Motors Corporation Dec. 1996

PWEE9615

Denotes non-reusable part.

Denotes tightening torque.

This number corresponds to the number appearing in "Removal steps", "Disassembly steps", "Installation steps" or "Reassembly steps".

Operating procedures, cautions, etc. on removal, installation, disassembly and reassembly are described.

Issue date

Publication number-Revision code

NOTES